

# N10

1U Passive Cooler

**PRODUCT SPECIFICATIONS**

## Table of Contents

1. PRODUCT DESCRIPTION .....	2
2. THERMAL PERFORMANCE CURVE.....	2
3. EP DRAWING .....	3
4. DM DRAWING .....	4
5. ROHS CERTIFICATE .....	5

## Model Number : N10

- Intel® Ice Lake and Cooper Lake Server Processor Socket FCLGA4189-4 / -5 ( Socket P4 / P5 or P+ )
- Passive Cooler for 1U Server or up

## Overall Specification

Dimension	113 x 78 x 27 mm
Weight	420 g
Material	Copper1100 for both Vapor Chamber Base and Fin Stack
Mounting Sets	Intel standard Anti-Tilt Rotating heat sink captive mounting sets
Package Carrier	PHM Package Carrier is included
Thermal Grease	Shin-Etsu 7762 or Equivalent
TDP	Support CPU Power up to 205 Watts Heat Dissipation

## Performance Chart: Passive Cooler N10 Thermal Resistance VS. Airflow

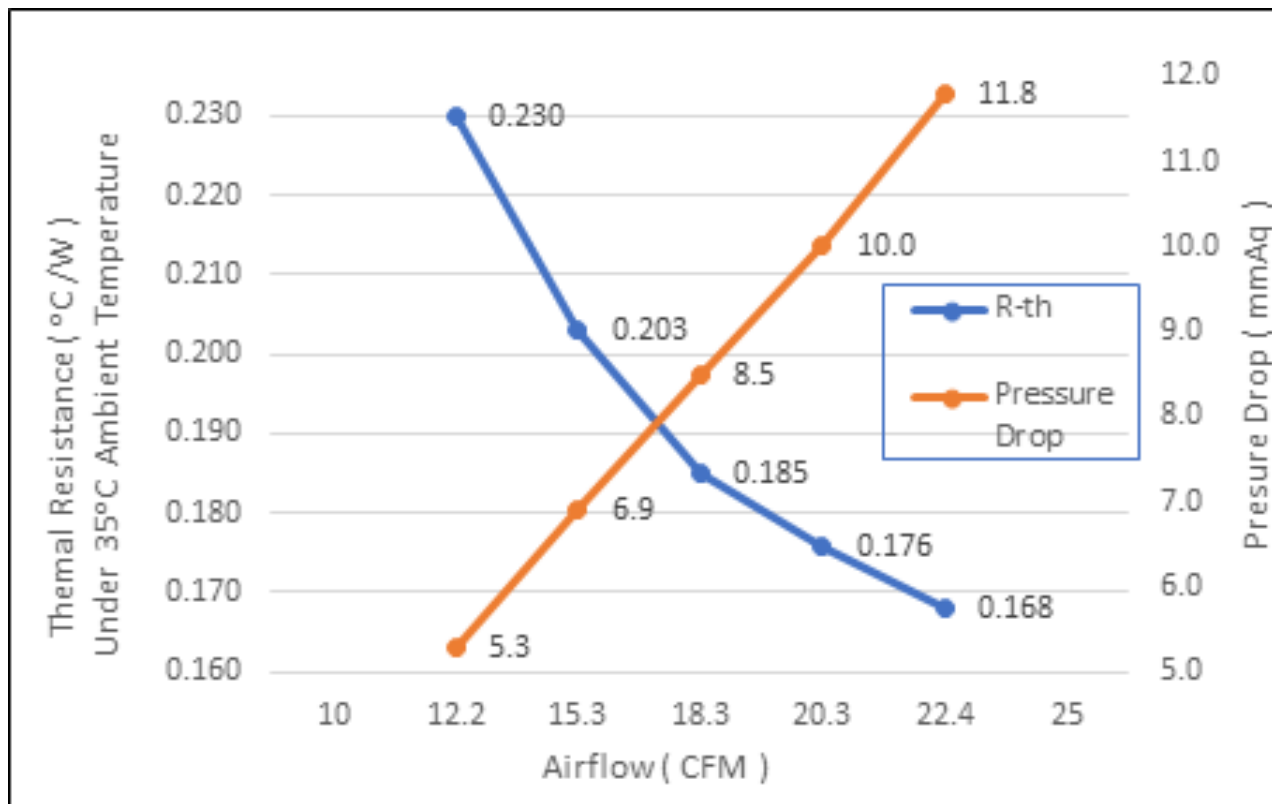

(Tested by Intel Ice Lake TTV)

**CONFIDENTIAL DOCUMENT**

THIS DRAWING CONTAINS INFORMATION PROPRIETARY TO DYNATRON CORPORATION AND DYNAEON INDUSTRIAL CO., LTD. ANY REPRODUCTION, DISCLOSURE, OR USE OF THIS DRAWING IS EXPRESSLY PROHIBITED EXCEPT AS DYNATRON CORPORATION AND DYNAEON INDUSTRIAL CO., LTD. MAY OTHERWISE AGREE TO IN WRITING.

REV#	DESCRIPTION	CHECKER	DATE
0.0	INITIAL RELEASE	LANG	09/21/2020

**ASSEMBLY PARTS**

**WHOLE SET OF HEATSINK**

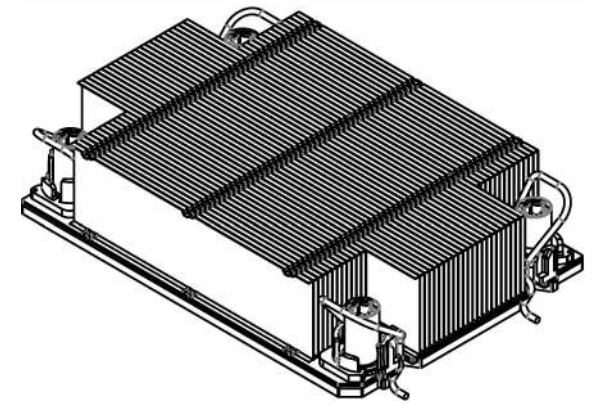
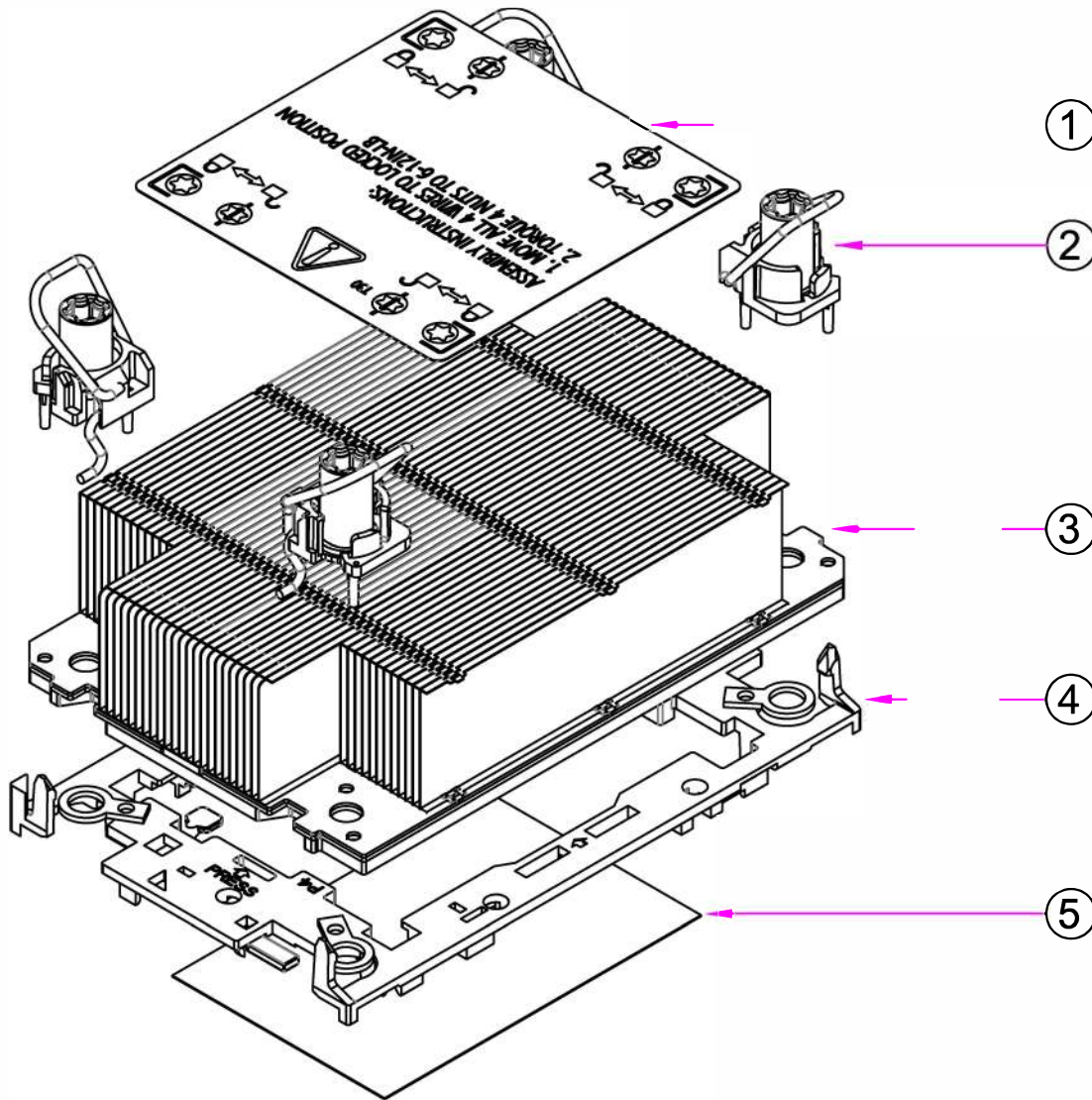

5	THERMAL GREASE, PRE-PRINTED	SHIN-ETSU 7762	1
4	INTEL PACKAGE CARRIER, P4	PLASTIC	1
3	HEATSINK, with STACKED FINS	COPPER FIN STACK COPPER VAPOR CHAMBER BASE STEEL RETENTION	1
2	ANTI-TILT ROTATING WIRE ASSEMBLY SET	PLASTIC NUT AND CAPTIVATION STEEL ROTATING WIRE	4
1	MOUNTING INSTRUCTION LABEL	PLASTIC	1
ITEM#	DESCRIPTION	MATERIAL	QTY.

**NOTES:**

1. THE FIGURE IS FOR REFERENCE ONLY, AND NOT FOR SCALE
2. OVERALL DIMENSION : 113 x 78 x 27 mm
3. OVERALL WEIGHT : 420 g

	DATE	NAME	 <b>DYNATRON CORPORATION</b>			
DRAWN	09/21/2020	Engr				
CHECKED	09/21/2020	LANG	<b>TITLE:</b> <b>1U Passive Cooler N10</b> <b>BOM &amp; Exploded Assembly Drawing</b>			
ENG. APPR.						
MFG. APPR.						
G.A.						
COMMENTS:			DWG. No:	<b>DYN-EP-N10</b>	REV	0.0

REV#	DESCRIPTION	CHECKER	DATE
0.0	INITIAL RELEASE	LANG	09/21/2020

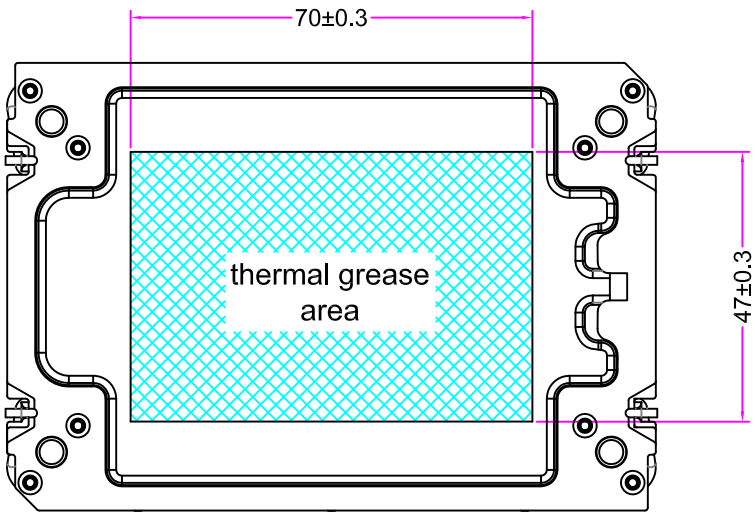
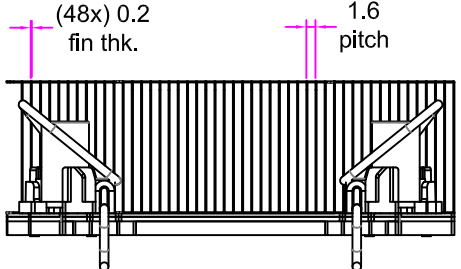
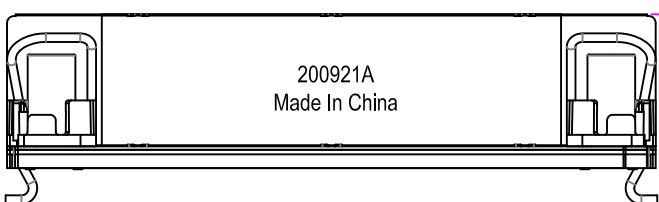
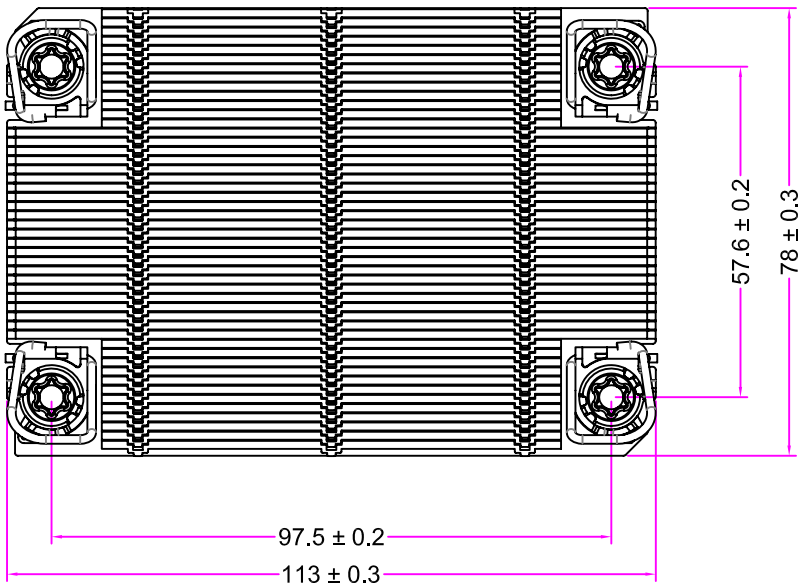

	NAME	DATE
DRAWN BY	engr	09/21/2020
CHECKED BY	LANG	09/21/2020
ENG. APPROVED		
MFG. APPROVED	-	-



DYNATRON CORPORATION

TOP MOTOR

TITLE: 1U Passive Cooler **N10**  
Overall Dimension Drawing

**CONFIDENTIAL DOCUMENT**  
THIS DRAWING CONTAINS INFORMATION PROPRIETARY TO DYNATRON CORPORATION AND DYNAEON INDUSTRIAL CO., LTD. ANY REPRODUCTION, DISCLOSURE, OR USE OF THIS DRAWING IS EXPRESSLY PROHIBITED EXCEPT AS DYNATRON CORPORATION AND DYNAEON INDUSTRIAL CO., LTD. MAY OTHERWISE AGREE TO IN WRITING.

VIEW	
UNITS	MM

DWG. No: **DYN-DM-N10**

REV. **0.0**



## Certificate of Environment Protection

### 環保證明書

<b>Customer:</b> 客戶名稱:	<b>Company:</b> _____ <b>Address:</b> _____ <b>Phone Number:</b> _____ - _____ - _____
<b>Issue Date:</b>	02/02/2021
<b>Product Model Number:</b>	N10
<p><b>Dynatron Corporation</b> hereby declares and certifies that all components manufactured are RoHS compliant according to the definitions and restrictions given by the European Union's Restriction (Directive 2002/95/EC) (Decision2011/65/EU)RoHS 2, on the restriction of the use of certain Hazardous Substances in the electrical and electronic equipment. Also, compliance to the most recent list of substances on the REACH candidate list.</p> <p><b>Number of substances on the Candidate List: 168 (last updated: 17/12/2015)</b></p> <p>No exemptions are claimed in order for the part to be compliant with the RoHS directive.</p> <p><b>Dynatron Corporation / 政久興業股份有限公司</b>證明所有產品,零件 (包括附屬品, 包裝類) 之環境管理物質完全符合 RoHS, WEEE, 及該環保標準之規定, 並承諾遵循以上之證明.</p> <p style="text-align: right;"><b>Dynatron Corporation.</b> 33200 Western Ave, Union City, CA 94587</p> <p><b>Title (職務):</b> _____ ASSISTANT-MANAGER _____</p> <p><b>Signature (簽字):</b> _____ <i>Alan Lee</i> _____</p> <p style="text-align: right;">Date: 02 / 02 / 2021</p>	

